

This document is our property and shall not without our permission be altered, copied, used for manufacturing or communicated to any other person or company.

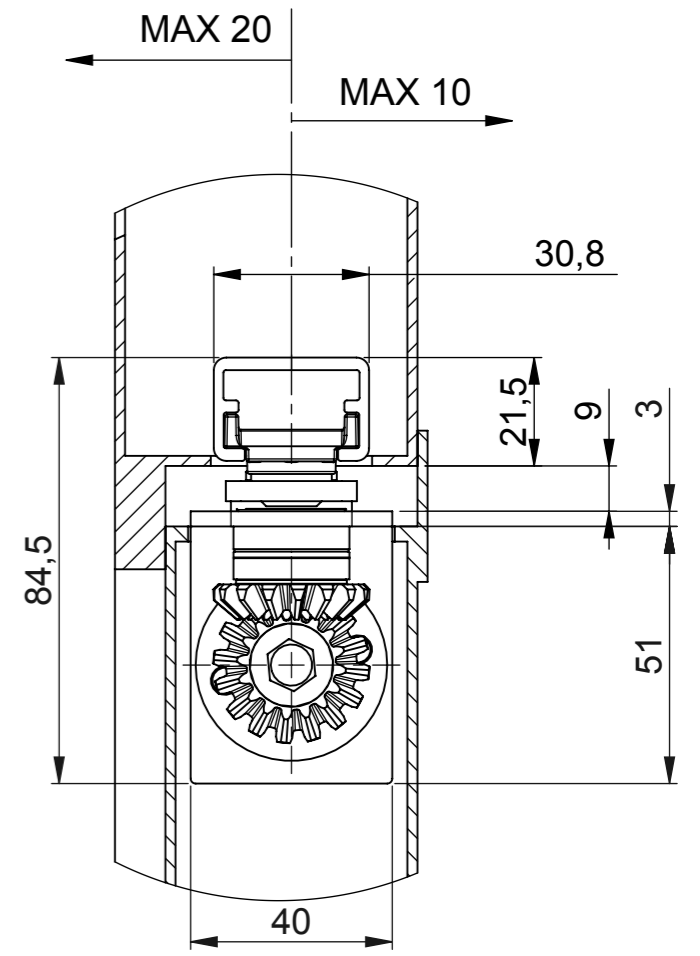
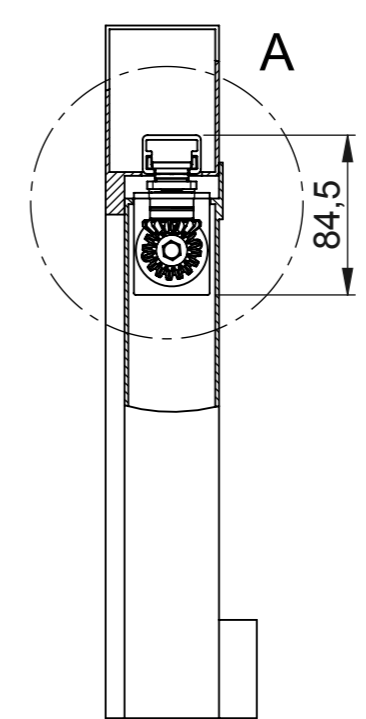
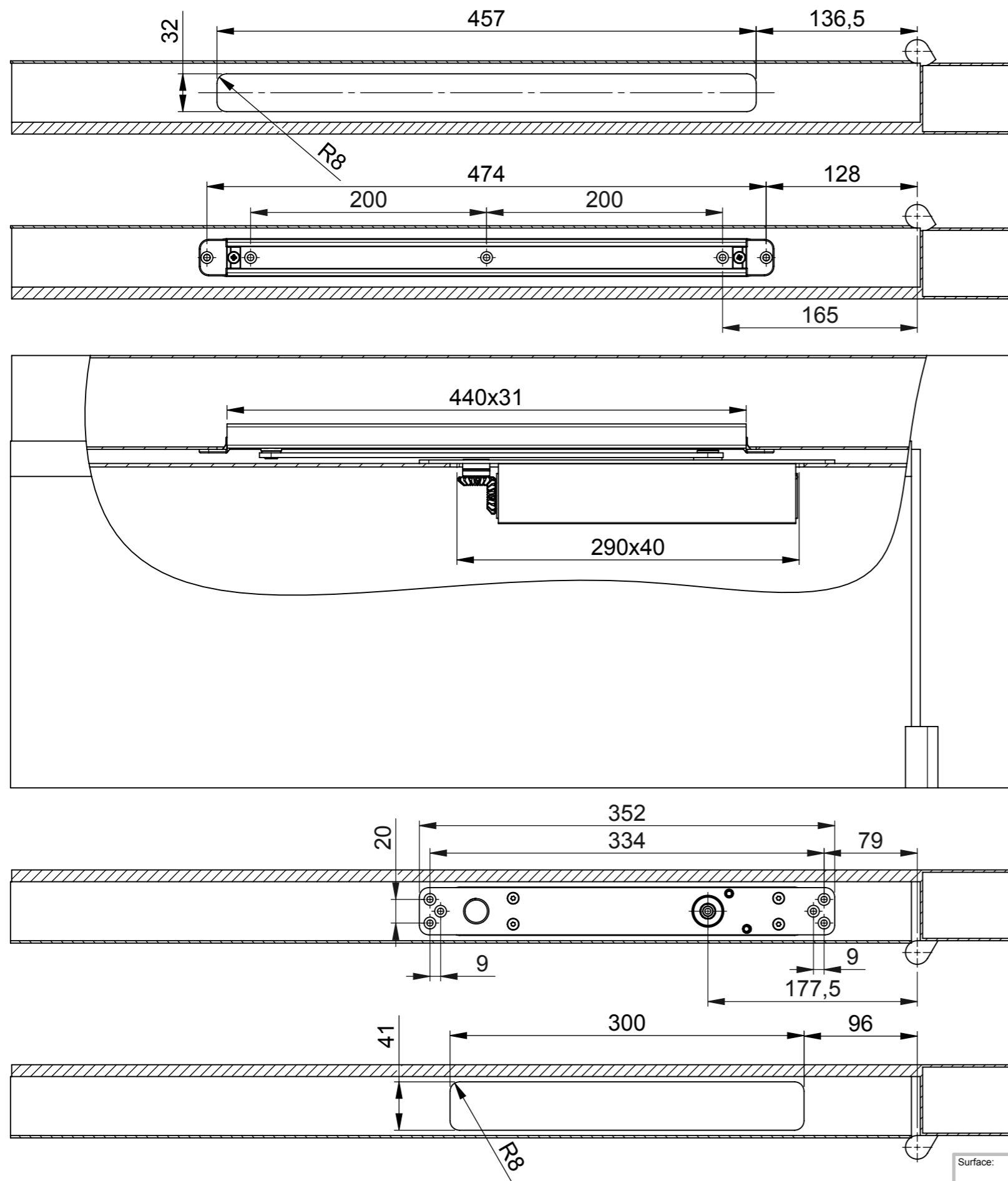

Detail A

Surface:			Material:			General tolerance:		
Volume:	Weight:	Surface area:	created:	designed by:	changed by:	Scale:	Projection:	
			JARKKOL 11.9.14	JARKKOL 11.9.14	JARKKOL 11.9.14	1:4 (A3)		
ASSA ABLOY						DC860+DC893 Metal Doors (Door installation) Without fixing plates		Alternate ID
								Document ID